

# GMR 326 D

LKO 1

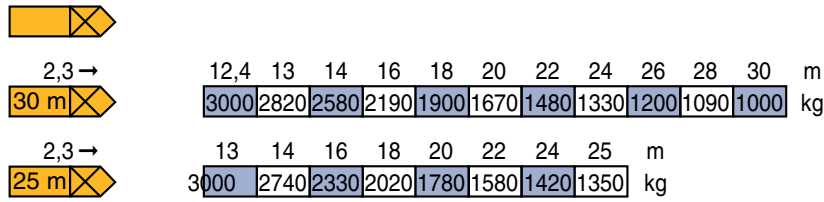

**Courbes de charges - Lastkurven - Load diagrams - Curvas de cargas - Curve di carico**



**Flèche relevée - Ausleger in Steilstellung - Luffing jib - Flecha izada - Braccio impennato**

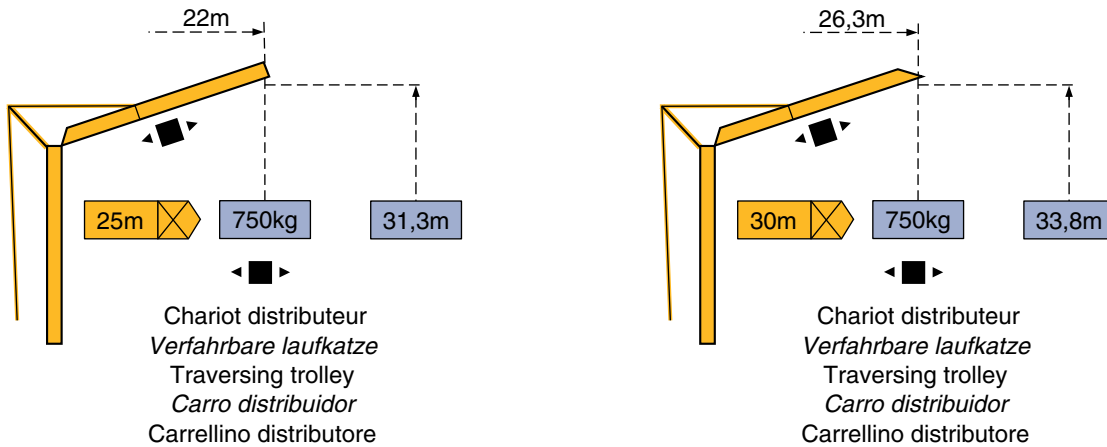

**Réaction - Eckdrücke - Reactions - Reacciones - Reazioni**

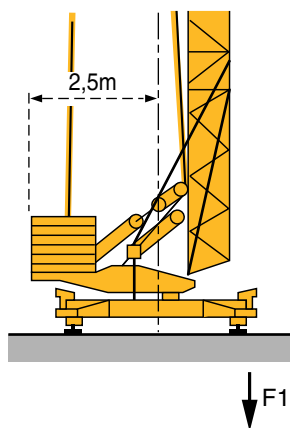

F1	● 17t	■ 10t
	10,8t	

Version sur vérins  
Ausführung auf Abstützspindeln  
Jacks version  
Versión sobre gatos  
Versione su stabilizzatori

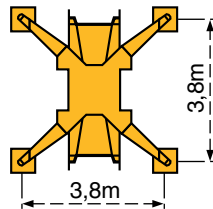

Version voie droite  
Ausführung gerade Schienenbahn  
Straight track version  
Versión vía recta  
Versione traslazione diritta

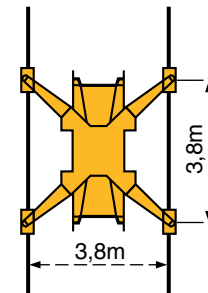

● En service  
■ Hors service

● In Betrieb  
■ Ausser Betrieb

● In service  
■ Out of service

● En servicio  
■ Fuera de servicio

● In servizio  
■ Fuori servizio

 A vide sans lest ni train de transport avec flèche et hauteur maximum.











 Ohne Last, Ballast und Transportachse, mit Maximalausleger und Maximalhöhe.

 Without load, ballast or transport axles, with maximum jib and maximum height.

 Sin carga, sin lastre, ni tren de transporte, flecha y altura máxima.

 A vuoto, senza zavorra ne assali di trasporto con braccio massimo e altezza massima.

## Mécanismes - Antriebe - Mechanisms - Mecanismos - Meccanismi

				m/min	kg	ch -PS hp	kW
Levage Heben Hoisting Elevación Sollevamento	15 TDPC 10 			8	1500	5	3,7
				25	1500	15	11
				4	3000	5	3,7
				12,5	3000	15	11
				25	2000		
		Distribution - <i>Katzfahren</i> - Trolleying Distribución - Distribuzione		3D1 V5	35		4,5
		3D2 V5	22 - 44	4,5	3,3		
Orientation - <i>Schwenken</i> - Slewing Orientación - Rotazione		RCV 20	0 → 1 tr/min U/min - rpm		3	2,2	
Translation - <i>Kranfahren</i> - Travelling Traslación - Traslazione		TVD 121	25		2x1,4	2x1	
Réseau - <i>Netzstrom</i> - Mains supply - <i>Red</i> - Rete elettrica					CEI 38 IEC 38	400V(+6%-10%) 50 HZ	
Puissance électrique nécessaire - <i>Anschlusswert</i> - Necessary electric power <i>Potencia eléctrica necesaria</i> - Potenza elettrica necessaria					20 kVA		
Groupe électrogène - <i>Stromaggregat</i> - Generator set - <i>Grupo electrogeno</i> - Gruppo elettrogeno					*		

\*Nous consulter - *Auf Anfrage* - Consult us - *Consultarnos* - Consultateci

Conforme aux directives CEE 84/534 et 87/405 sur le niveau acoustique - *Gemäss EWG-Richtlinien 84/534 und 87/405 für den Schall- Leistungspegel*  
 In compliance with the EEC 84/534 and 87/405 instructions on noise level - *Conforme con las directivas CEE 84/534 y 87/405 sobre el nivel acustico*  
 Conforme alle direttive CEE 84/534 e 87/405 sul livello acustico

## Montage - Montage - Erection - Montaje - Montaggio

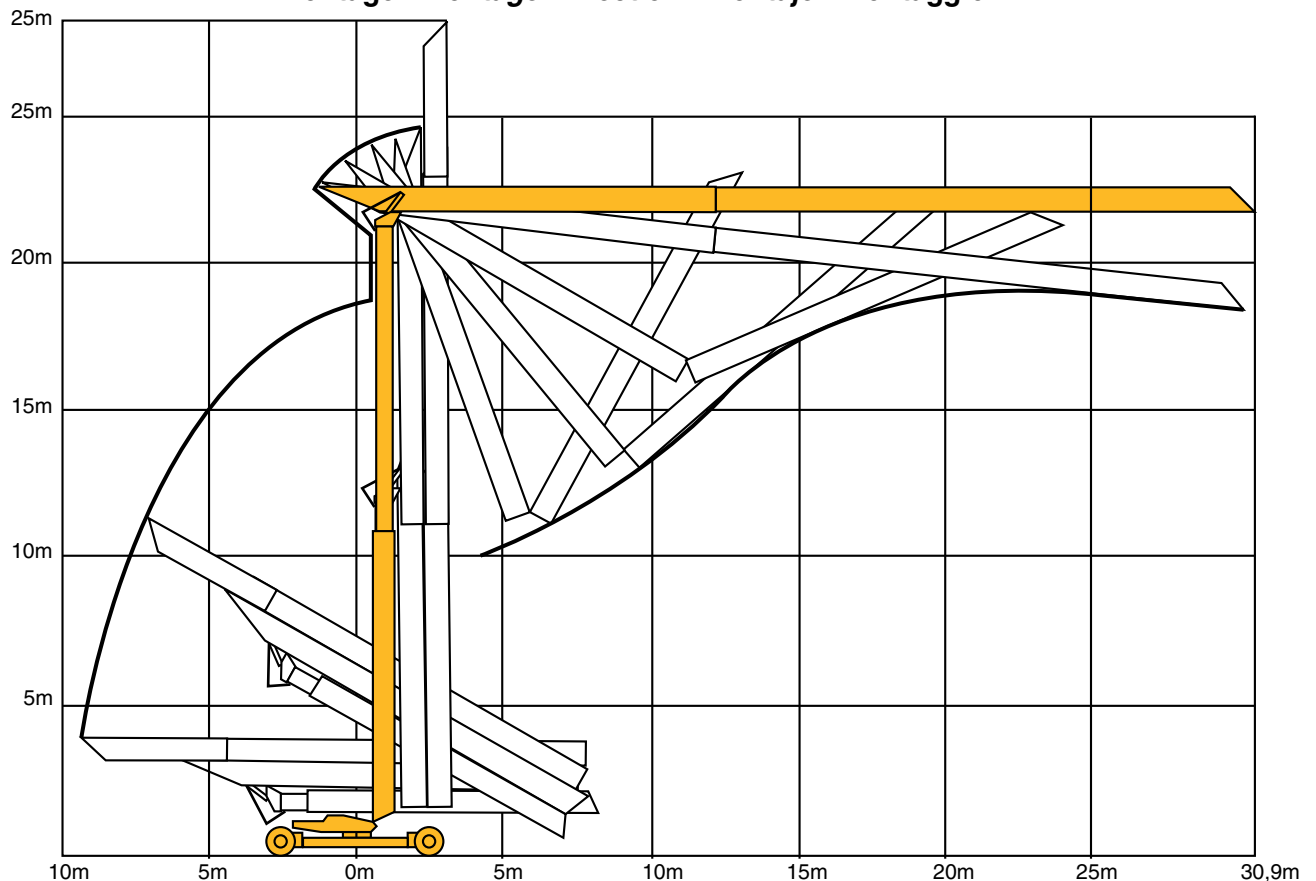

Transport - *Transport* - Transport - *Transporte* - Trasporto

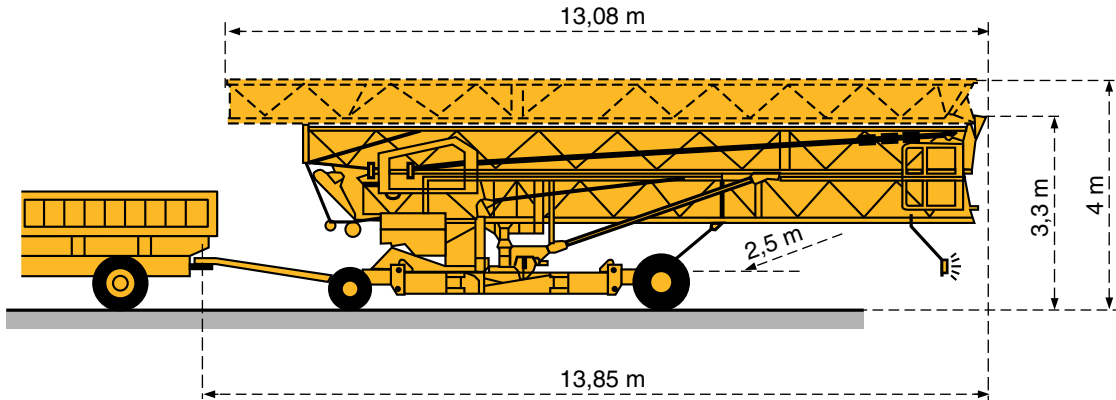

Version tractée derrière camion  
 Ausführung als LKW Anhänger  
 Lorry towed version  
 Versión remolcable detrás de un camión  
 Versione trainata da camion

Version semi-portée : Nous consulter  
 Ausführung als Sattelaufliieger : Auf Anfrage  
 Tractor towed version : Consult us  
 Versión en semi-remolque : Consultarnos  
 Versione semi rimorchio : Consultateci



NF E 52081 - 82  
 DIN 15018.H1 B3

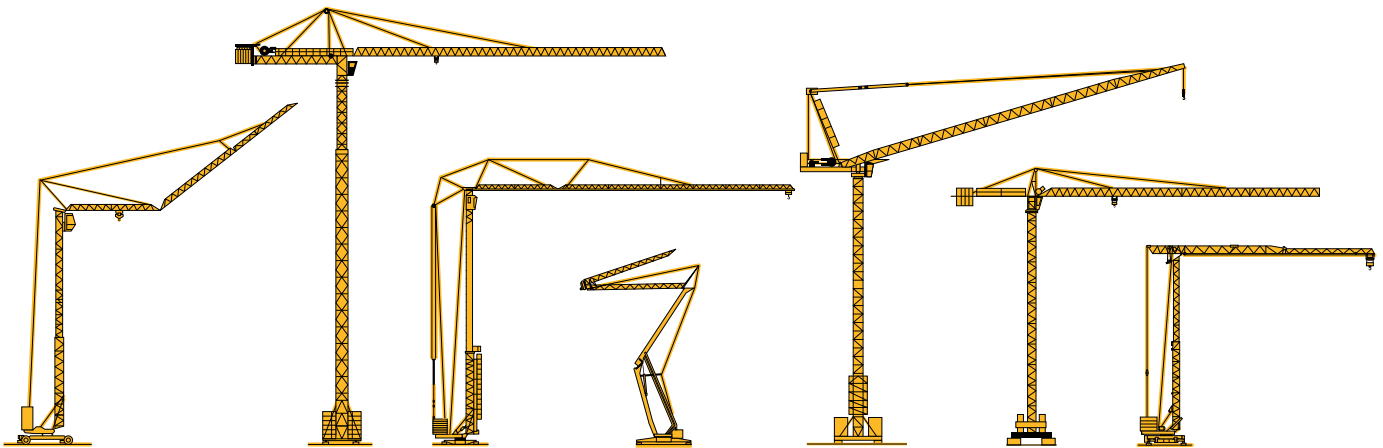

Document pour usage commercial uniquement - *Benutzung dieser Unterlagen nur für Verkaufszwecke* - Document for commercial use only -  
 Documento para uso comercial unicamente - Documento para uso commerciale solamente

Copyright.Reproduction interdite © POTAIN 1996



18.Rue de Charbonnières, B.P. 173-F 69132 ECULLY Cedex  
 Tél. (33)04.72.20.20.20 - Fax (33)04.72.20.20.00  
 http://www.potain.fr - E-mail : mkt@potain.fr

POTAIN GmbH Deutschland Tel : 06.105.704.0  
 SIMMAPOTAIN Italia Tel : 039.65.631  
 Zhangjiagang POTAIN China Tel : 520. 877.1451



**GMR 326 D**

Réf. 1996.43 LKO 2

Modifications réservées / Modificaciones reservadas / Modifiche riservate / Subject to modification / Änderungen vorbehalten / Printed in France

Réalisation SODIPE